

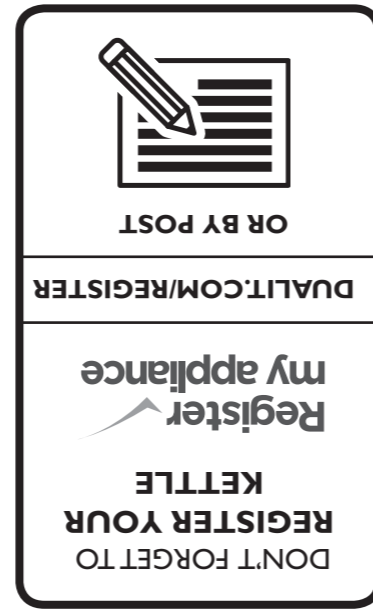

- Read this instruction manual before you start using the kettle. It gives you important safety information and will ensure you get the most out of your Dualit kettle.
- Keep this manual and your proof of purchase in a safe place.
- All illustrations are for representation only, your model may have a different appearance from illustrations shown.



Classic Kettle
Instruction Manual



TROUBLESHOOTING

IMPORTANT: FAILURE TO DESCALE AND CLEAN YOUR MACHINE WILL INVALIDATE YOUR GUARANTEE.
*TO CONTACT CUSTOMER SERVICES, PLEASE EMAIL INFO@DUALIT.COM WITH YOUR MODEL AND SERIAL NUMBERS.

POSSIBLE CAUSE(S)	SOLUTION(S)
THE KETTLE DOES NOT TURN ON	
1. The kettle may not be properly connected to the power supply or the fuse may have failed.	1. Check the plug is in the socket and the switch is turned on. Replace the fuse if necessary.
2. Boil dry feature may have been activated. If the kettle is accidentally switched on with no water inside, the boil-dry device will switch off the heating element to prevent damage to the kettle.	2. Wait 10 minutes for the kettle to reset.
3. The element may have broken if the power neon illuminates but the kettle does not boil.	3. The element can be replaced. Contact customer services* for servicing information.
4. The kettle does boil but the power neon does not illuminate.	4. The power neon may have blown. For further assistance contact Dualit customer services*.
THE KETTLE IS SPUTTERING OUT OF THE SPOUT	
1. You may have over filled the kettle.	1.1 Only fill to the max mark (1.7L). 1.2 Wait 10 seconds to allow the boiling water to settle before pouring.
2. The kettle may have descaling solutions remaining inside the body.	2. Follow the instructions from the cleaning & care section and rinse thoroughly.
3. The filter may not be in position.	3. Ensure the filter is in position. For spare parts please visit www.dualit.com/support or contact Dualit customer services* for help.
MY KETTLE IS NOT SWITCHING OFF	
1. Limescale may have built up inside the kettle.	1. Descale your kettle regularly (see Limescale Warning).
2. Check the lid is firmly closed during use.	2. Pips on inner lid rim can be pushed in to create a tighter fit.
3. Water may have gone down the steam tube whilst filling. You may have overfilled, tilted the kettle when filling or filled through the spout.	3. Leave the kettle for 24 hours to fully dry.
MARKS HAVE APPEARED IN THE KETTLE	
1. Small brown spots can build up inside the kettle. This is not rust, small deposits of scale which contain iron can build up inside the kettle.	1. Descale regularly (see Limescale warning).
THE KETTLE LEAKS FROM THE LID	
1. The lid seal may be damaged or have a build up of limescale.	1. Replace the seal. For spare parts please visit www.dualit.com/support or contact Dualit customer services* for help.
WATER DROPLETS COLLECTS ON TOP THE POWER BASE	
1. This is condensation and perfectly normal.	1. Dry with non abrasive cloth.



IMPORTANT SAFETY PRECAUTIONS



READ ALL INSTRUCTIONS BEFORE USING THE APPLIANCE KEEP THESE INSTRUCTIONS FOR FUTURE REFERENCE

• THIS IS AN ATTENDED APPLIANCE

Do not leave appliance unattended during use, unplug after each use (risk of fire if an unattended appliance is left operating or plugged in).

- This appliance must not be used by children younger than 8 years old and persons with very extensive and complex disabilities. Children aged 8-14 years and persons with reduced physical, sensory or mental capabilities or lack of experience and knowledge shall not use this appliance, unless they are supervised and have been given instruction concerning the use of the appliance in a safe way and understand the hazards involved. Children shall not play with the appliance. Cleaning and user maintenance shall not be made by children unless they are older than 8 and supervised. Keep the appliance and its cord out of reach of children less than 8 years old.
- This appliance is intended for household use only. If the appliance is used improperly or for professional or semi-professional purposes or if it is not used according to these instructions the Guarantee becomes invalid and Dualit refuses any liability for damage caused.

Electrical safety

- Before connecting to the mains supply. Check that the voltage marked on the appliance corresponds with the supply voltage. **Risk of electric shock and fire.**
- NOTE: Any plug cut from the power supply cord should be disposed of immediately. Inserting any cut off plug into a 13A socket-outlet is hazardous. **Risk of electric shock and fire.**
- Never use the plug without the fuse cover fitted. Ensure replacement fuse is the same current value as the original. Replacement fuses are available and should be ASTA approved to BS1362. **Risk of electric shock and fire.**
- In order to avoid a hazard, if the Power Cord is damaged it must, for safety reasons, be replaced by Dualit or an authorised Dualit repairer. Call Dualit's Customer Helpline on +44 (0) 1293 652 500. **Risk of electric shock and fire.**
- To protect against electric shock, do not immerse any part of this product or cordset in water or other liquid.
- A short Power Cord is provided to reduce risks resulting from becoming entangled in or tripping over a longer cord. **Risk of scalding.**
- Do not operate any appliance with a damaged lead or plug, or after the appliance malfunctions or has been dropped, damaged or cracked in any manner. **Risk of electric shock and fire.**

General safety

- NOTE: When you lift the kettle from the Base you will see drops of moisture on the surface of the Power Base. This is the steam used to switch the kettle off automatically. This then condenses and escapes through Vents in the underside of the kettle. This is perfectly normal and should not be cause for alarm or returning the kettle.
- Do not operate the kettle unless the Water Filter is correctly in position.
- Do not operate the kettle unless it contains at least 250ml of water and the floor of the kettle is covered.
- Do not fill via the Spout.
- Do not use if dropped, cracked or damaged. **Risk of scalding and electric shock.**
- Do not use the kettle for any purpose other than heating water. **Otherwise, this will result in an injury caused by misuse.**
- Do not place the kettle, Power Base or mains lead on or near any hot surface, hot hob, gas burner or in a heated oven.
- Ensure that the kettle is correctly positioned on the Power Base before switching on.
- Do not operate the kettle on an inclined plane.
- Do not use in bathroom or outdoors. **Risk of electric shock.**
- Do not fill above the 'max' mark on the Water level Indicator. **Risk of fire and electric shock.**

- Remove the kettle from its Power Base before filling or pouring.
- Ensure that the Lid is fully closed before switching the kettle on, otherwise it may not properly switch off and take longer to heat water.
- Do not remove or open the Lid while the water is heating.
- Do not move the kettle while it is switched on.
- Use Handles or Knobs – **do not touch hot surfaces.**
- If the kettle is overfilled, hot water may be ejected. **Risk of scalding and electric shock.**
- When heating, hot steam will be emitted from the kettle. **Scalding will occur if you are within 400mm of the Lid or Spout.**
- Ensure that the kettle Spout is pointing away from any electrical plug or socket.
- **Scalding will occur if the Lid is opened during the heating cycle and the body of the kettle will get hot.**
- Take care when pouring – pour slowly and do not over-tilt the kettle.
- Water will remain hot for a considerable time after heating and can present a scald hazard. Keep the kettle, Power Base and the mains lead away from the edge of worktops and out of the reach of children. **Risk of scalding. Keep out of reach of children.**
- Avoid spilling of any liquid on the connector. **Risk of electric shock.**
- Use the kettle only with the Power Base supplied and vice versa.
- The use of accessory attachments not recommended by Dualit may result in fire, electric shock or injury to persons.
- This kettle features boil-dry protection. If the kettle is accidentally switched on without water, the boil-dry device will switch off the heating element to prevent damage to the kettle. Wait approximately 10 minutes for the kettle to cool down, lift and refill as normal. The kettle is now ready to use again. NOTE: If discolouration of the heating plate has occurred, this can be easily removed by descaling your kettle.
- Allow the kettle to cool down completely before cleaning and storing.
- To disconnect, remove plug from wall outlet.
- Unplug the Power Base from the wall socket when not in use, or before moving and cleaning.
- Do not store or use in an appliance garage or under cupboards. **Risk of fire.**
- CAUTION: To prevent damage to the appliance, do not use alkaline cleaning agents. When cleaning, use a soft cloth and a mild detergent. **Risk of electric shock.**
- Do not use scouring pad or abrasive cleaner on the appliance body. **Risk of electric shock.**
- Do not heat the kettle if filled with descaling solution.
- Visit our website for full specification and instructions



SAVE THESE INSTRUCTIONS

In the interest of improving products, Dualit Ltd. reserves the right to change the product specification without prior notice.

INSTRUCTIONS ON ENVIRONMENT PROTECTION

Do not dispose this product in the usual household garbage at the end of its life cycle. Please hand it over to a collection point for the recycling of electrical and electronic appliances. The symbol on the product, the instruction of use or the packaging will inform you about the methods of disposal. The materials are recyclable as mentioned on its marking. By recycling, material recycling or other forms of re-utilization of old appliances you are making an important contribution to protect our environment. Please enquire at the community administration for the authorised disposal location.

IMPORTANT: BEFORE FIRST USE

- Before using the kettle for the first time or if it has been out of use for a long time, fill to the 'max' mark and boil. Discard all of the boiled water then rinse the kettle out with fresh cold water. Repeat 3 times. Carefully inspect the inside of the kettle and remove any debris.
- Unpack the box with care, keeping all the packaging materials until you are satisfied everything is present and in working order. Once satisfied, remove all packaging and tags from the appliance body and recycle the packaging appropriately. Do not remove tags from the cord. You may wish to keep the box to store your appliance.

KNOW YOUR CLASSIC KETTLE

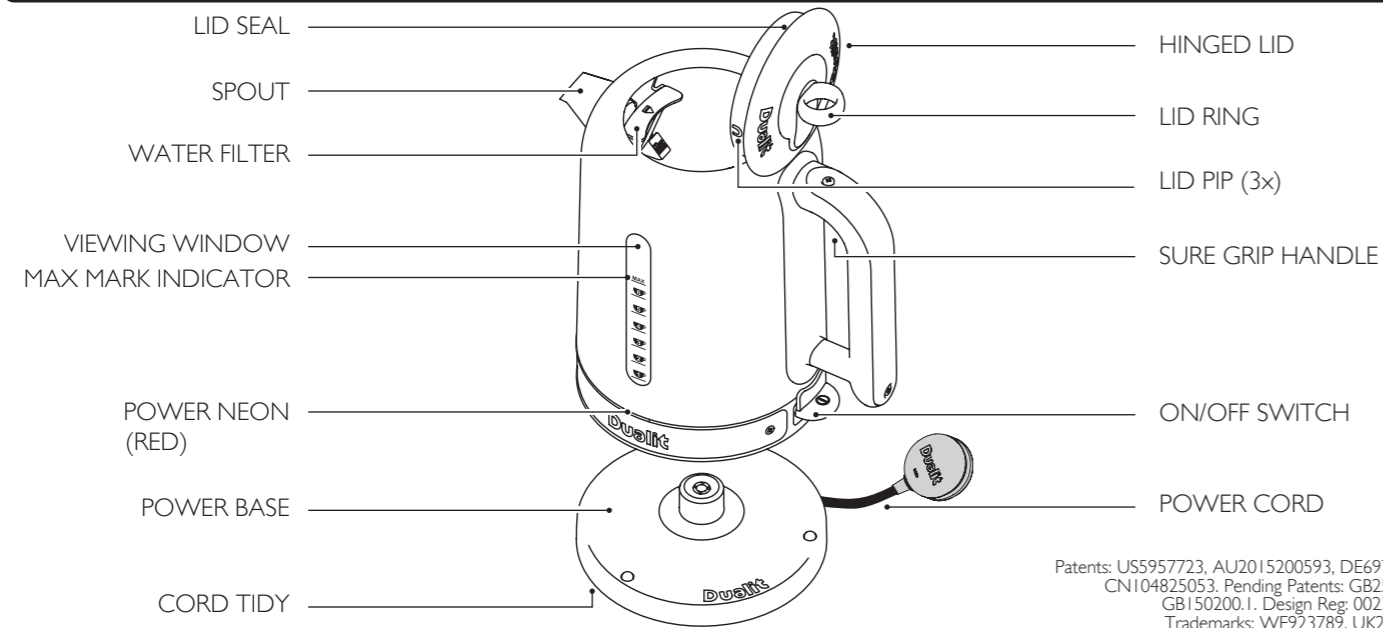

Patents: US5957723, AU2015200593, DE69701177, CN104825053, Pending Patents: GB2524872, GB150200.1, Design Reg: 002399337, Trademarks: WE923789, UK2416444

SETTING UP

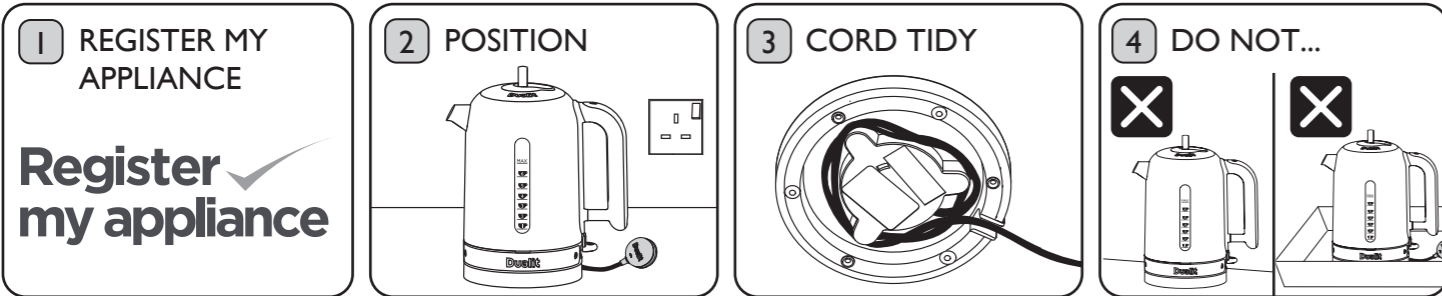

Register your appliance at www.dualit.com. This will only take 60 seconds. You will need the product model and serial numbers that are on the rating label on the base of the product.

Place your kettle as close to the wall socket as possible. **DO NOT STORE OR USE YOUR KETTLE IN APPLIANCE GARAGE OR UNDER CUPBOARDS. RISK OF FIRE.**

Use the shortest cord possible. Wrap excess cord around the Cord Tidy under the Power Base.

Do not operate on an inclined plane. Do not operate in a tray.

FILLING YOUR KETTLE

WARNING: IF THE KETTLE HAS JUST BOILED IT WILL BE FULL OF STEAM THAT WILL ESCAPE AS SOON AS THE LID IS OPENED. THE LID WILL BE HOT. USE THE LID RING TO OPEN AND CLOSE THE LID. RISK OF SCALDING.

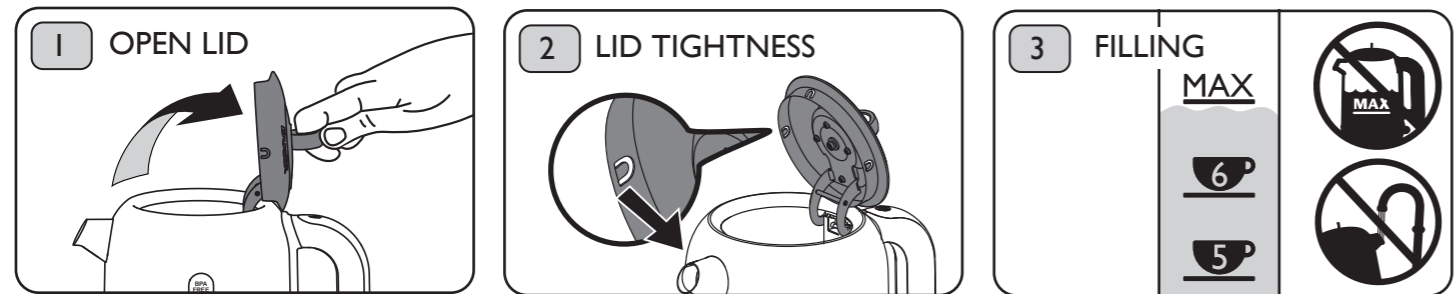

Ensure that the kettle is unplugged. Remove the kettle from the Power Base. Lift the Lid by gently pulling the Lid Ring up and back. **CAUTION: WHEN HEATING HOT STEAM WILL BE EMITTED FROM THE KETTLE. SCALDING WILL OCCUR IF YOU ARE WITHIN 400MM OF THE LID OR SPOUT.**

Tip: If the Lid is too tight try pushing in the pips on the inside of the Lid with a spoon handle. Pushing the Lid pips back out will give a tighter fit. **WARNING: IF THE LID IS TOO LOOSE, RISK OF SCALDING.**

Fill the kettle through the Lid opening. Use at least one cup of water (250ml). The water level must stay below the Max Mark Indicator. Save energy by only heating what you require. Keep kettle upright and level at all times when filling. Do not tilt kettle backwards. **Do not overfill or fill through the Spout. Risk of scalding.** Push the Lid down using the Lid Ring to close. **WARNING: if the kettle has just boiled the Lid will be hot.**

BOILING WATER

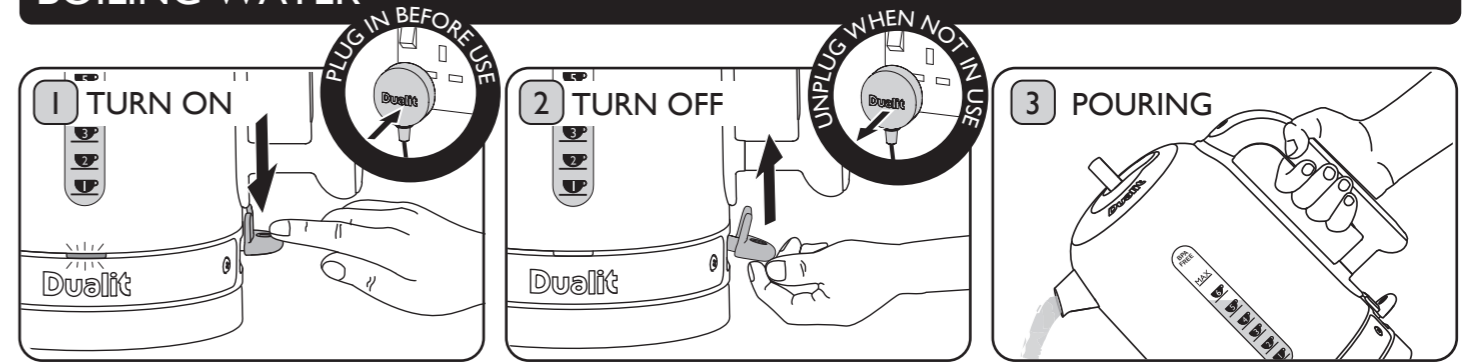

Place the kettle on the Power Base. Plug the kettle into a power socket. Press the On/Off Switch down. The Power Neon will illuminate and the kettle will start to heat up. If the kettle is accidentally switched on with no water inside, the boil-dry device will switch off the heating element to prevent damage to the kettle.

The kettle will automatically turn off after the water has boiled. To turn off before the water has boiled lift up the On/Off Switch.

DO NOT LEAVE THE APPLIANCE UNATTENDED DURING USE. UNPLUG AFTER EACH USE. RISK OF FIRE IF AN UNATTENDED APPLIANCE IS LEFT OPERATING OR PLUGGED IN.

Remove kettle from the Power Base. To avoid risk of splashing, once the kettle has boiled wait 10 seconds then pour slowly. Do not over-tilt the kettle.

LIMESCALE WARNING!

LIMESCALE BUILD UP
It is important to regularly descale your kettle to prevent limescale building up over time. This build up can cause damage to your kettle and alter the way your hot drinks taste. Follow these steps to minimise limescale build up in your kettle: Empty the kettle after each use; do not leave water in the kettle overnight. Use filtered water instead of tap water. Avoid using bottled water as this is classed as hard water.

DESCALE REGULARLY
Dualit recommends descaling regularly; at least once every 2 months. If you live in a hard water area you may need to descale more often. See our Water Hardness map to determine how often you should descale your kettle. Dualit recommends Kilrock K Multi-Purpose Descaler. This can be purchased from www.dualit.com. Other descalers can be used; follow the instructions on the packaging. When descaling has finished empty the kettle and rinse it out a minimum of 3 times with fresh water. Refill with fresh water, boil, then discard the boiled water. **FAILURE TO DO SO CAN CAUSE INJURY. DO NOT HEAT KETTLE WITH DESCALING SOLUTION IN IT.**

WATER HARDNESS	Hardness level	Soft	Medium	Hard
	CaCO ₃ mg/l	0-100	101-200	201+
ACTION FREQUENCY	Descale	At least once every 4 months or every 200 cycles.	At least every 2 months or every 100 cycles.	At least once per month or every 50 cycles.

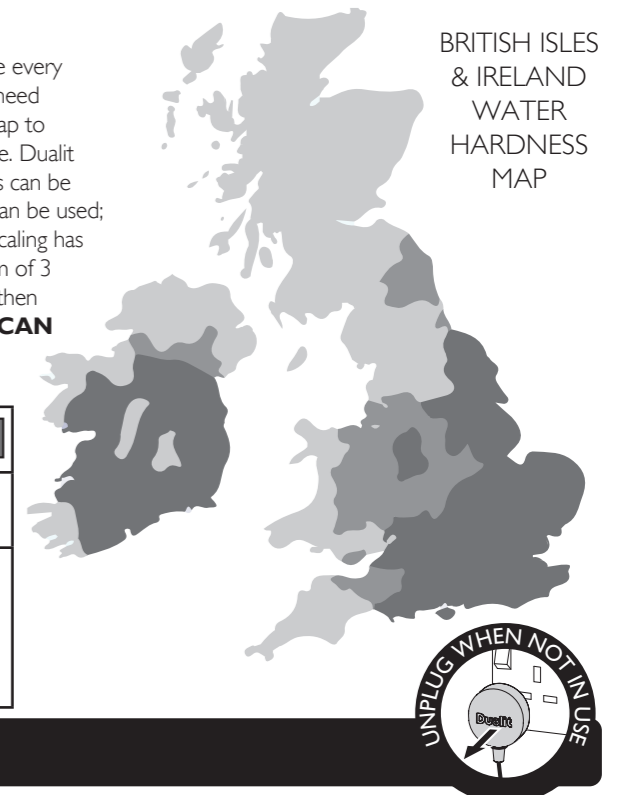

CLEANING & CARE

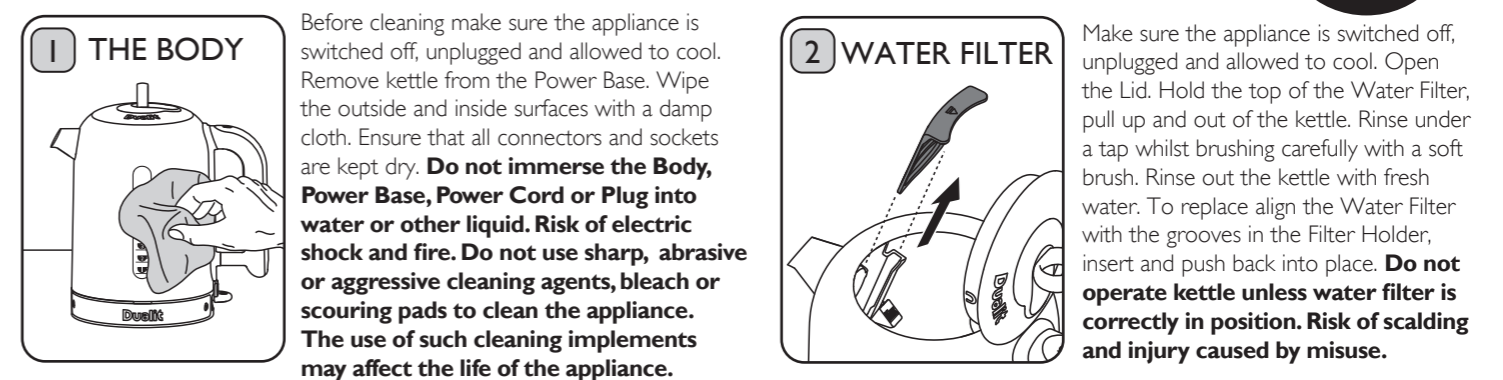

KETTLE REPAIR

Core components of your kettle are replaceable!
The Classic Kettle has been built to last, but should you experience any fault with your kettle, please contact Dualit for advice. The Classic Kettle is repairable and fitted with a patented, repairable element. Simply contact our helpline on 01293 652 500 or visit www.dualit.com/support for repair or servicing advice. All servicing must be carried out by Dualit or authorised repair agent. For your own protection only use original Dualit spares in your kettle. Fitting of non Dualit parts will invalidate the guarantee.