

3 in 1 Coffee Machine

Instruction Manual & Guarantee

Dualit®

Since 1945

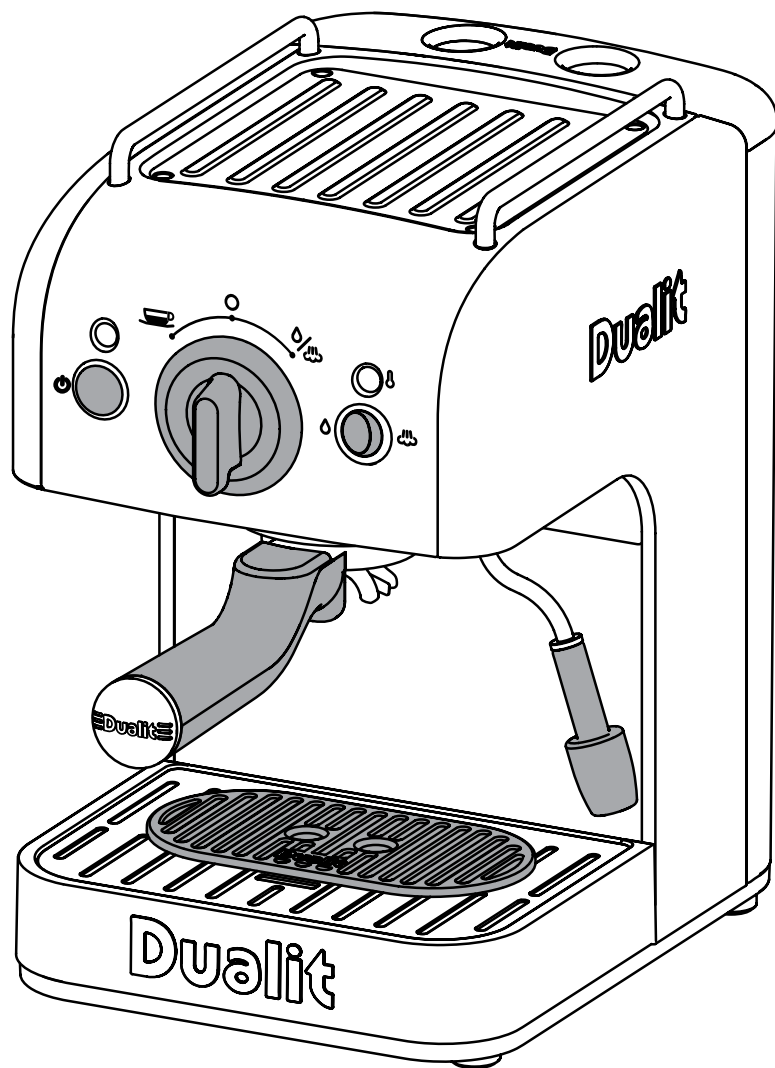
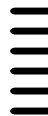

YOUR 3 IN 1 COFFEE MACHINE

High pressure espresso machines, such as your new Dualit 3 in 1 Coffee Machine, require constant care and maintenance to prolong their life.

Please remember to:

- **Rinse through and wipe the Steam Wand after every use.**
- **Descale your machine on a regular basis.**
- **Your machine is fitted with an energy saving feature. If left for approximately 30 minutes it will automatically switch off.**
- **Unplug when not in use.**

PERFECT PARTNER

(SOLD SEPARATELY)



BARISTA SET

www.dualit.com/barista-set



DUALIT CUPS

More sizes available at
www.dualit.com/coffeecups



DUALIT'S COFFEE CAPSULE RANGE

www.dualit.com/capsules



ECOPRESS

www.dualit.com/ecopress

CONTENTS

Your 3 in 1 Coffee Machine	02
Safety precautions	04
Before first use	05
Limescale warning	06
Know your 3 in 1 Coffee Machine	08
Priming - before each coffee	10
The Capsule Piercing Tool	11
Using Dualit & Nespresso® compatible* Capsules	12
Using ESE coffee pods	14
Using ground coffee	15
The Espresso shot	16
Frothing milk	17
Dispensing hot water	19
Cleaning - after each use	20
Cleaning - monthly	21
Descale regularly	23
Recipes	26
Troubleshooting guide	27
Guarantee	30

DON'T FORGET TO REGISTER YOUR PRODUCT	WWW.DUALIT.COM/REGISTER	Register my appliance ✓
	OR BY POST	

Unpack the box with care, keeping all the packaging materials until you are satisfied everything is present and in working order. Once satisfied remove any tags from the appliance body and recycle the packaging appropriately. Do not remove tags from the cord. You may wish to keep the box to store your appliance.

All illustrations are for representation only, your model may have a different appearance from illustrations shown.

*Suitable for Nespresso® drop through machines, excluding professional machines and 'built-in' models. Nespresso® trademark is owned by Société des Produits Nestlé S.A.



IMPORTANT SAFETY PRECAUTIONS



READ ALL INSTRUCTIONS

READ ALL INSTRUCTIONS BEFORE USING THE COFFEE MACHINE. KEEP THESE INSTRUCTIONS FOR FUTURE REFERENCE.

IMPORTANT SAFEGUARDS

• **THIS IS AN ATTENDED APPLIANCE. Do not leave unattended during use, unplug after each use (risk of fire if an unattended appliance is left operating).**

• This appliance must not be used by children younger than 8 years old or persons with very extensive and complex disabilities. Children aged 8-14 years and persons with reduced physical, sensory or mental capabilities or lack of experience and knowledge shall not use this appliance, unless they are supervised and have been given instruction concerning the use of the appliance in a safe way and understand the hazards involved. Children shall not play with the appliance. Cleaning and user maintenance shall not be made by children unless they are older than 8 and supervised. Keep the appliance and its cord out of reach of children less than 8 years old.

• This appliance is intended for indoor household use only. If the appliance is used improperly or for professional or semi-professional purposes or if it is not used according to these instructions the Guarantee becomes invalid and Dualit refuses any liability for damage caused.

Electrical safety

- Ensure that the voltage of the appliance corresponds to that of the mains supply. **Risk of electric shock and fire.**
- **WARNING:** This appliance must be earthed.
- In order to avoid a hazard, if the Power Cord is damaged it must, for safety reasons, be replaced by Dualit or a qualified electrician. Call Dualit's Customer Helpline on +44 (0)1293 652 500. **Risk of electric shock and fire.**
- Never touch the Power Cord with wet hands. **Risk of electric shock.**

• Do not pull the Power Cord over sharp edges, clamp it or allow it to hang down. It should not be allowed to come into contact with hot or damp surfaces. **Risk of electric shock.**

• This appliance conforms to directive 2014/30/EU regarding electromagnetic compatibility.

• The use of extension cables not authorised by the manufacturer may cause damage or accidents. **Risk of electric shock.**

General safety

• Do not operate any appliance with a damaged Power Cord or plug, or after the appliance malfunctions or has been dropped, damaged or cracked in any manner. **Risk of electric shock and fire.**

• The use of accessory attachments not recommended by Dualit may result in **fire, electric shock or injury to persons.**

• The appliance's plug must fit into the mains socket properly. Do not alter the plug. Do not use plug adaptors. **Risk of electric shock.**

• Never use the plug without the fuse cover fitted. Ensure replacement fuse is the same current value as the original. Replacement fuses are available and should be ASTA approved to BS1362. **Risk of electric shock and fire.**

• Do not use the appliance without water as this may cause damage to the Pump/Boiler.

• Do not touch the metal parts, the Filter Holder or its housing when the appliance is in use. **Risk of burns or scalding.**

• Do not place the appliance on a polished wood or permeable surface, it could damage the surface.

• Do not place the Coffee Machine on a metal tray or other metal surface during use. **Risk of electric shock.**

• Do not operate on an uneven surface. **Risk of injury.**

• Do not place the appliance over or close to sources of heat such as electric rings, hot ovens or open flames. **Risk of electric shock and fire.**

• Do not leave the appliance in a room with a temperature below 0°C, as any water remaining in the appliance could freeze and cause damage.

• Before refilling the Water Tank, unplug the appliance from the mains. **Risk of electric shock.**

• Do not overfill the Water Tank.

• Do not use sparkling water (with carbon dioxide).

• Never fill the Tank with hot or boiling water.

• Only use the appliance with the drip tray correctly fitted.

• Do not immerse in water or other liquids. **Risk of electric shock and fire.**

• If there is internal water leakage, do not operate the coffee maker and unplug it at once in order to avoid electric hazard. **Risk of electric shock.**

• Turn the appliance off and unplug when not in use. **Risk of electric shock and fire.**

• To prevent damage to the appliance do not use alkaline cleaning agents when cleaning, use a soft cloth and a mild detergent.

• Do not use a scouring pad or abrasive cleaner on the main body.

• Do not place on a tray or surface that may collect liquid. **Risk of electric shock.**

• Steam and hot water hazard. Do not come into direct contact with hot liquid and steam. **Risk of scalding.**

• Do not lift the appliance up using the water tank, Power Cord or Cup Rails. Only hold the appliance body. Unplug and allow to cool prior to moving.

• The Power Cord should not be allowed to come into contact with hot surfaces. **Risk of fire.**

• A short Power Cord is provided to reduce risks resulting from becoming entangled in or tripping over a longer cord. **Risk of injury and electric shock.**

• Never use a damaged or deformed capsule. Water could flow around the capsule when not perforated by the blades and damage the appliance. **Risk of scalding.**

• We recommend that the appliance is plugged into a socket that has no other appliance connected to it. Failure to do this may cause an overload, trip a circuit breaker or blow a fuse. Preferably the socket outlet should be protected by a residual current device (RCD).

• Do not come into contact with the Grouphead, Filter, Holder Body, coffee outlets or Steam Wand. The surface will be hot. Use Filter Holder Handle only. **Risk of scalding.**

• Unplug the appliance from the mains to allow to cool before cleaning, maintaining or moving. **Caution: Hot water.** For details, please refer to cleaning section. **Risk of fire, electric shock, scalding or injury to persons.**

• The appliance is not designed for commercial or industrial use; it is for domestic use only.

• Caution when using Milk Jug as edges may be sharp. **Risk of injury.**

• The coffee maker shall not be placed in a cabinet or appliance garage when in use. **Risk of fire.**

SAVE THESE INSTRUCTIONS

In the interest of improving products, Dualit Ltd. reserves the right to change the product specification without prior notice. All illustrations are for representation only, your model may vary from illustrations shown.

INSTRUCTIONS ON ENVIRONMENT PROTECTION



Do not dispose of this product in the usual household garbage at the end of its life cycle. Please hand it over to a collection point for the recycling of electrical and electronic appliances.

The symbol on the product, the instruction of use or the packaging will inform you about the methods of disposal. The materials are recyclable as mentioned on its marking. By recycling, material recycling or other forms of re-utilization of old appliances you are making an important contribution to protect our environment. Please enquire at the community administration for the authorised disposal location.

BEFORE FIRST USE

• Read this instruction manual before you start using the coffee machine. It gives you important safety information and will ensure you get the most out of your Dualit product.

• Keep this manual and your proof of purchase in a safe place.

• Don't forget to register your product at www.dualit.com/register.

• The Water Tank, Steam Wand, Measuring Spoon, Filter Holder and Frother Nozzle must be washed with warm soapy water, then rinsed and dried.

• **THE COFFEE & TEA MACHINE MUST BE FLUSHED THROUGH WITH WATER BEFORE THE FIRST USE. Follow the instructions for set-up as if priming the appliance. Leave the Filter Holder or NX[®] Adaptor empty, i.e. no ESE pod, no capsule and no ground coffee.**

• Empty the whole Water Tank through the Steam Wand and Coffee Filter; this will rinse the internals ready for brewing coffee.

NOTE: The Control Knob may be harder to turn when the machine is new. This will loosen with use.

LIMESCALE WARNING!

HARD WATER WILL CAUSE LIMESCALE BUILD-UP, RESULTING IN BLOCKAGES THAT WILL CAUSE PERMANENT DAMAGE OR WILL DECREASE THE LIFE OF YOUR MACHINE. TO PREVENT THIS, DESCALE REGULARLY AND USE A WATER SOFTENER.

IMPORTANT NOTICE: PRODUCT FAILURE DUE TO THE BUILD UP OF LIMESCALE IS NOT COVERED BY GUARANTEE.



HOW TO MANAGE LIMESCALE BUILD-UP

Before Use – Know Your Water Hardness:

- Confirm the hardness of your water with your local water company or use the quick reference map as a guide.
- **Find your water company on the OFWAT site (ofwat.gov.uk/contact-companies) and check the water hardness of your area.**
- If you are unable to establish the water hardness of your area, or require further support, contact Dualit Customer Services by emailing info@dualit.com.

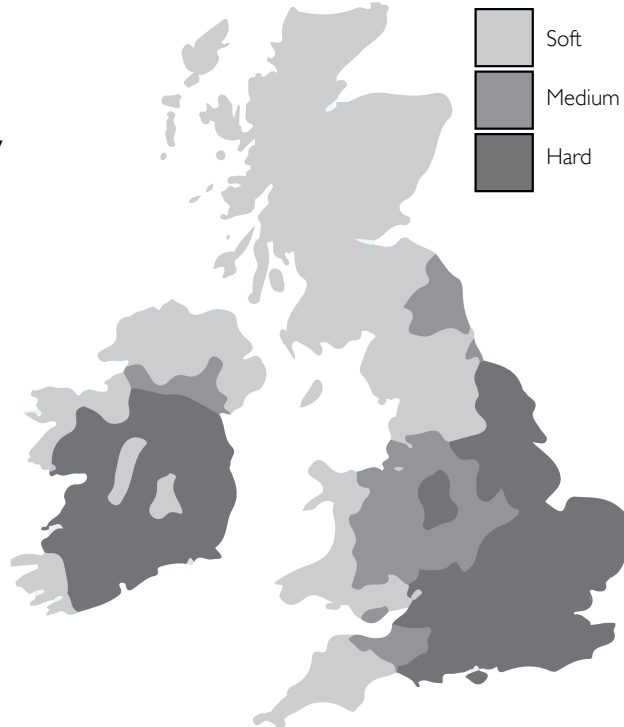
BRITISH ISLES WATER HARDNESS MAP



WATER HARDNESS		ACTION FREQUENCY		
Hardness level	CaCO ₃ mg/l	Descale	Water Softener	Slow Coffee Extraction or Drop in Steam Output
Soft 	0-100	At Least Once Every 2 Months or Every 100 Cycles	Replace Annually	Descale Immediately
Medium 	101-200	At Least Once Per Month or Every 50 Cycles	Replace Bi-Annually	Descale Immediately
Hard* 	201+	At Least Once per Month or Every 25 Cycles	Replace Bi-Annually	Descale Immediately

*Treat bottled water as hard water.

During Use - Water Softeners

You must use a Water Softener Bag (available at www.dualit.com) in medium and hard water areas, but Dualit recommends the use of a Water Softener in all areas. Follow the manufacturer's instructions for use. Replace the Water Softener Bag according to the table above.



During Use - Descaler

Dualit recommends using limescale removing solution (available at www.dualit.com). Follow the manufacturer's dosage and safety/handling precautions. Descale your appliance regularly according to the table above.

For further assistance, contact Dualit's Customer Services by emailing info@dualit.com.

- **See descale instructions for full descale procedure and further details.**
- **User must descale using a specific limescale removing solution, coffee machine cleaners will not descale your machine.**

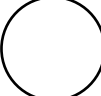
KNOW YOUR 3 IN 1 COFFEE MACHINE

MAINTENANCE KIT		
	20X FILTER PAPERS ALSO AVAILABLE FROM WWW.DUALIT.COM	 FILTER PIN
		 STEAM PIN

1.5L REMOVABLE WATER TANK

COFFEE/OFF/STEAM
CONTROL KNOB

POWER INDICATOR LIGHT

POWER BUTTON

BREWHEAD,
GASKET AND SHOWERHEAD

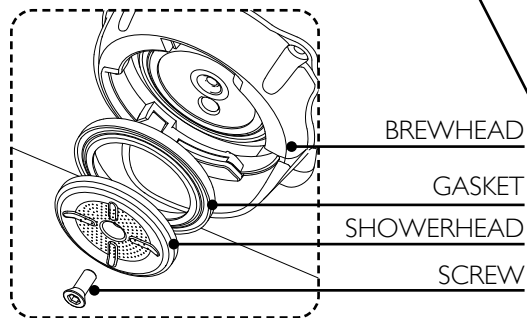

ESE POD FILTER

1 CUP FILTER

2 CUP FILTER

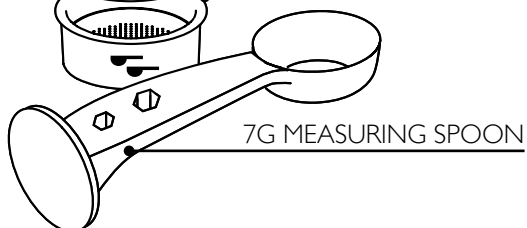

TRAY FULL INDICATOR

NON-SLIP RUBBER FEET

CUP HOLDING
PLATE WITH RAIL

TEMPERATURE INDICATOR

STEAM/WATER SELECTOR

STEAM WAND

FILTER HOLDER

FROTH NOZZLE

REMOVABLE DRIP TRAY
AND NON-SLIP MAT

CAPSULE PIERCING TOOL

NX® ADAPTOR

NX® ADAPTOR SEAL

NX® HOLDER

FILTER HOLDER

PRIMING - BEFORE EACH USE

The Brewhead, Filter Holder and cup must be the correct operating temperature before the first use. Thereafter, subsequent cups must be pre-warmed before **EACH** coffee.



1 REGISTER MY APPLIANCE

Register my appliance

Register your appliance at www.dualit.com. This will only take 60 seconds. You will need the product model and serial numbers that are on the rating label on the base of the product.

2 FILL WATER TANK

Fill the Water Tank with water; do not go above the 'MAX' mark. You will see air bubbles at the connection when correctly located.

3 TURN ON

Plug in Power Cord. Press Button to turn 'ON'. The Thermobloc Water Heater system is now heating to the correct temperature.

7 WARM CUP

If you like your coffee extra hot, the serving cup or mug must be warmed through before **EACH** coffee or tea. Dispense a cup full of water, then discard the water.

8 READY

Your machine is ready to go.

4 WAIT 40 SECONDS

The temperature neon will go out once the Thermobloc is at the correct operating temperature.

5 ATTACH HOLDER

Align the Holder with the open lock symbol, insert then rotate 60° past the closed lock symbol. **Ensure the Holder is fully locked before dispensing.**

6 PRE-HEAT FILTER HOLDER

Dispense a cup full of water (min 240ml) through the machine. Ensure **NO** coffee is in the Cup Filter Holder.

THE CAPSULE PIERCING TOOL

1 Choose your capsule (if your capsule does not require piercing, skip to page 12).

⚠ CAUTION! Capsule Piercing Tool has sharp blades, use with care. ⚠

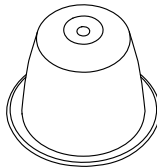
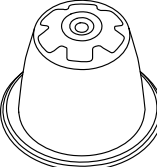
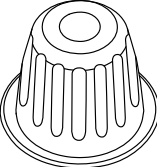
CAPSULE TYPES		
PIERCER REQUIRED TO ACTIVATE CAPSULE & INDUCE EXTRACTION		
		
Nespresso®* Capsules	Dualit Compostable+ Capsules	Dualit Aluminium Capsules

*Suitable for Nespresso® drop through machines, excluding professional machines and 'built-in' models. Nespresso® trademark is owned by Société des Produits Nestlé S.A.

*Suitable for industrial composting through authorised food waste collection schemes.



Yes required



Not required

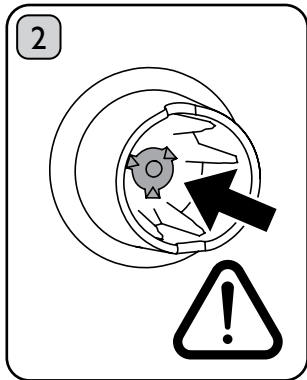

CAUTION! Sharp blades, use with care.

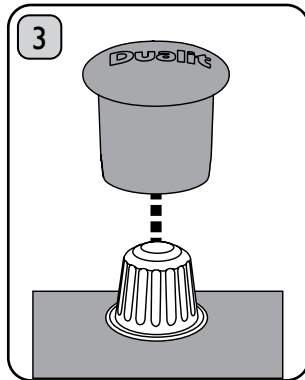

Place Capsule on a flat surface. Place Capsule Piercer Tool over the Capsule.

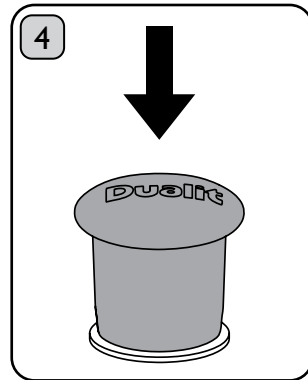

Gently apply pressure. Ensure Capsule Piercer Tool meets with Capsule rim. Capsule is ready to use.

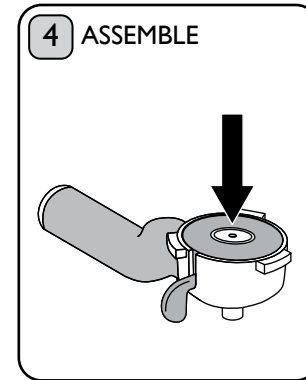

Lower the Adaptor to assemble and lock Capsule in Holder.

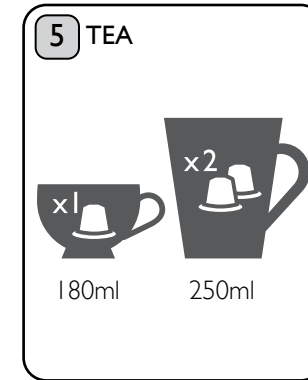

For a tea cup (150-180ml) we recommend using 1 Capsule (depending on your strength preference). For a mug (250ml) use 2 Capsules.

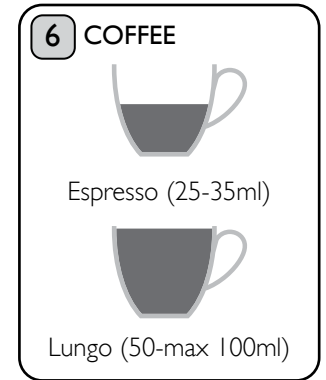

We recommend extracting 50 to a maximum of 100ml from 1 Lungo Capsule. For all other flavours extract 25-35ml to make an espresso. For larger volumes of coffee, use another Capsule.

USING DUALIT & NESPRESSO® COMPATIBLE CAPSULES

Select the NX® Holder with the grey handle. Every capsule is a sealed masterpiece of flavour. Dualit offer exceptional recyclable aluminium and environmentally friendly Compostable+ Capsules. Choose your favourite, unlock the aroma and enjoy.



Our range of Coffee Capsules are available in retail stores, Amazon and at www.dualit.com/capsules-order.

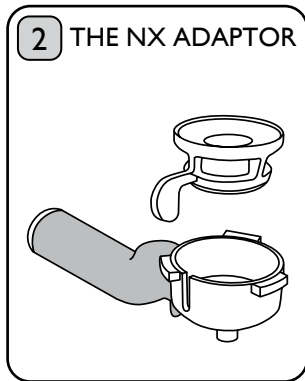

Select the NX Adaptor and NX Holder. This Holder and Adaptor is for use with Dualit and Nespresso® capsules only.

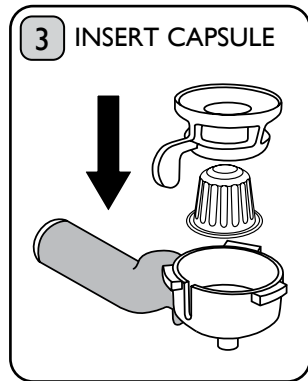

Pierce the capsule if required (see page 11-12), then place in the NX Holder and align the Adaptor.

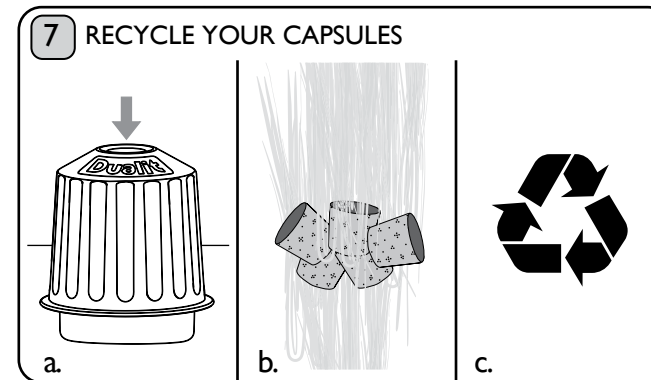

Dispose of aluminium capsules using *EcoPress™ to empty the capsule (a) then rinse to remove any remaining grounds (b) and place in your recycling bin (c). Dualit compostable capsules should be disposed of via your council food waste collection. Plastic capsules to be disposed of via household waste. Please check with your local council that they are able to accept compostable capsules in food waste collection.

*EcoPress™ available to purchase from www.dualit.com.

NOTE: For a hotter drink, warm the cup first with a shot of hot water and discard.

*Suitable for Nespresso® drop through machines, excluding professional machines and 'built-in' models. Nespresso® trademark is owned by Société des Produits Nestlé S.A.

USING ESE COFFEE PODS

ESE pods are individually wrapped and pre-tamped ensuring the perfect espresso every time. Look for the ESE logo on compatible coffee pods. **THE MAXIMUM RECOMMENDED EXTRACTION IS 35ML PER ESE POD.**

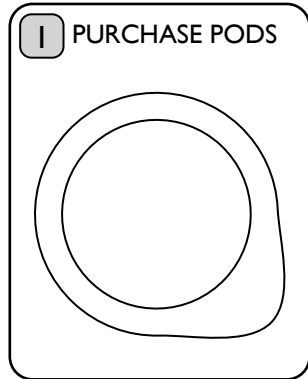

Coffee Pods are available directly from retail outlets, www.dualit.com/coffee-pods or contact Dualit Customer Services by emailing info@dualit.com.



Select the ESE Pod Filter and snap into the Filter Holder.

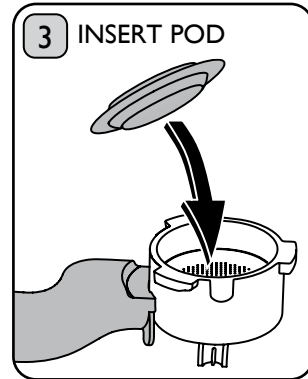

Place one fresh coffee pod into the ESE Filter. Each pod is individually wrapped so you only use what you need.

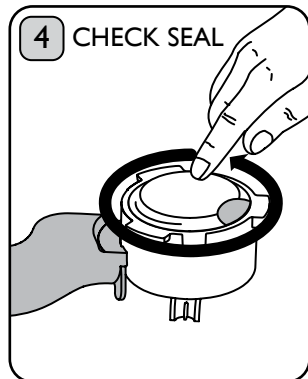

Make sure there is no gap between the pod and Filter edge, or water will flow round the pod and your espresso will be diluted.

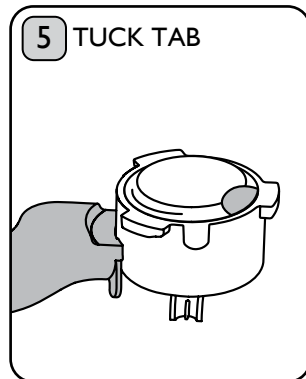

Make sure all the paper is tucked inside the Filter Holder before attaching the Filter Holder to the Brewhead.

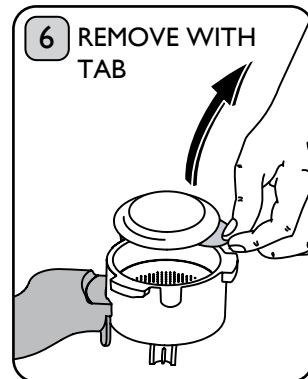

Use the tab to remove the pod once the coffee has been made.

USING GROUND COFFEE

Ground coffee has a three-day shelf-life, so only grind what you need. Use a medium grind suitable for espresso machines. **Too fine** might block your Filter; **too coarse** will mean you get a weak, under-extracted espresso.

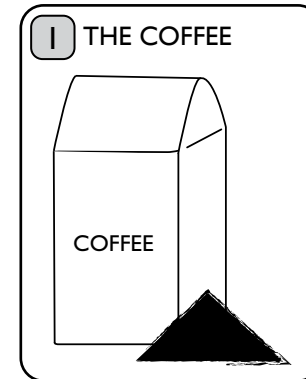

Freshly grind your beans using setting 3-5 on the Dualit Burr Coffee Grinder, 4-6 on the Dualit Handheld Grinder or use a pre-ground coffee suitable for espresso machines.

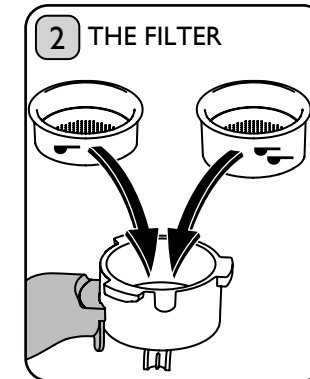

Select the appropriate sized Cup Filter depending on whether you are making one espresso, a double or two singles. Make sure it is dry.

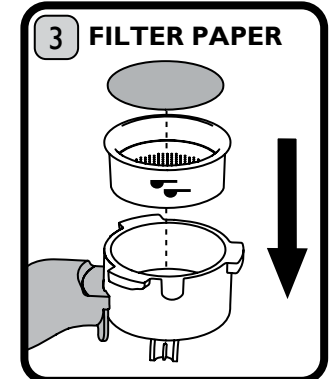

IMPORTANT NOTICE: Some very small coffee grounds can block the Cup Filters. To prolong the life of your machine use the enclosed Filter Papers with each serving.

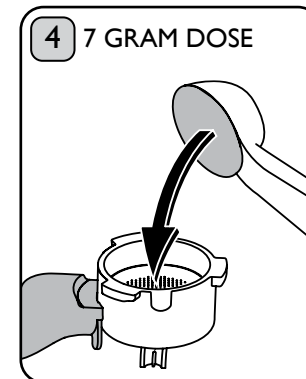

Using the Measuring Spoon, measure out one level spoon per serving into the Cup Filter. Use 2 level spoons if using the 2 Cup Filter.

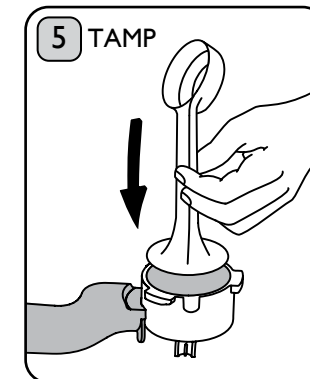

With the other end of the Measuring Spoon, 'tamp' the coffee grounds **LIGHTLY**. Tamping too hard, will stop water flowing through the ground coffee.

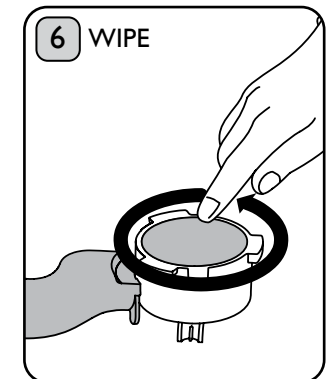

Wipe the edge of the Cup Filter clean. If you don't, a water tight seal will not form and water or coffee will leak from the Brewhead. Please refer to page 16-17 for extraction steps.

THE ESPRESSO SHOT

The basis of all the coffee drinks is the espresso shot.

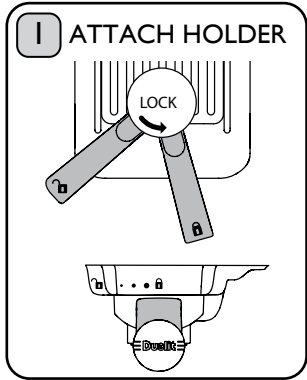

Align the Filter Holder with the open lock symbol, insert, then rotate 60° past the closed lock symbol. **Ensure the Filter Holder is fully locked before dispensing. Risk of scalding.**

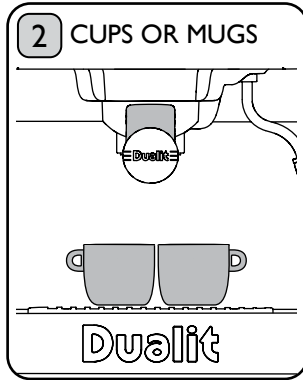

Place 1 or 2 warmed cups or a mug under the nozzles of the Filter Holder. Make sure your cups are directly under both nozzles.

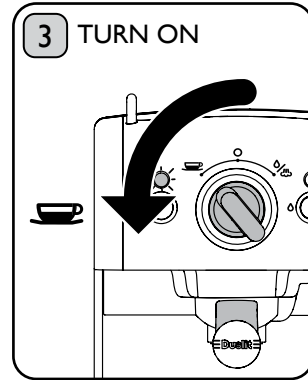

To extract your espresso, turn the Control Knob anti-clockwise to the cup symbol. You will hear the pump operating.

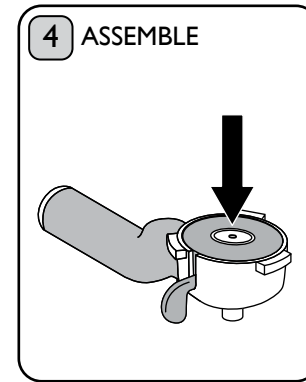

Lower the Adaptor to assemble and lock Capsule in Holder.

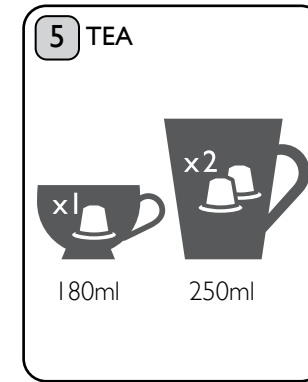

For a tea cup (150-180ml) we recommend using 1 Capsule (depending on your strength preference). For a mug (250ml) use 2 Capsules.

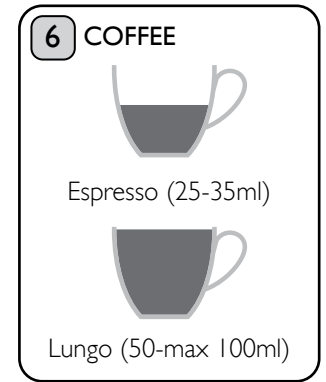

We recommend extracting 50 to a maximum of 100ml from 1 Lungo Capsule. For all other flavours extract 25-35ml to make an espresso. For larger volumes of coffee, use another Capsule.

NOTE: For a hotter drink, warm the cup first with a shot of hot water and discard.

FROTHING MILK

IMPORTANT NOTICE: AFTER EACH USE, WIPE THE STEAM WAND & FLUSH THE INSIDE OF THE WAND BY DISPENSING WATER THROUGH THE WAND.

CAUTION! Take care when using the Milk Jug, as edges may be sharp. **CAUTION!**

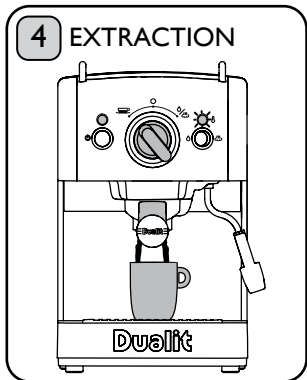

The espresso will flow out of the Filter Nozzles. This may take a few seconds. The Temperature Light may cycle on / off; this is normal.

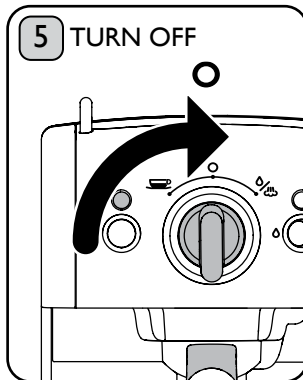

When the cup has been filled to the desired level (about 15-20 seconds for an espresso) turn the Control Knob to the '0'. Then press the Power Button and **Unplug when not in use.**



When using the Filter Holder, knock out the grounds over a bin. Rinse the Filter under running water to remove any coffee grounds. Use the Filter Pin to unblock the Filters or NX® Adaptor if required.

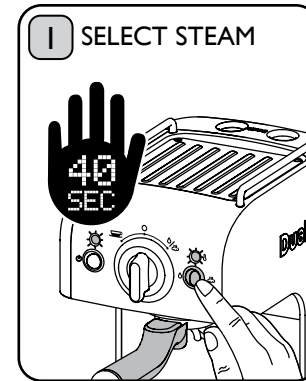

Set the Steam/Water Selector to the steam setting. The Temperature Indicator will go out when the correct temperature has been reached.

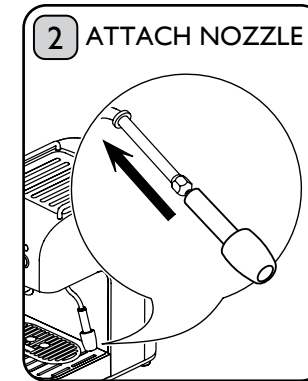

Put the Froth Nozzle on the end of the Steam Wand. Push up against the stopper shown above. **Caution: Wand may be hot. Risk of scalding.**

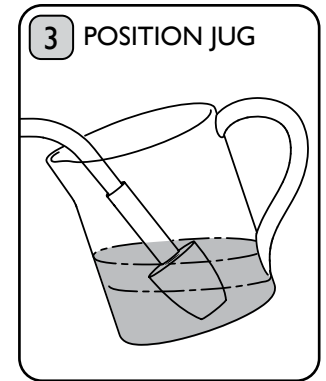

Use 75-200ml of **cold semi-skimmed milk in a stainless steel jug.** Position the head of the Froth Nozzle just under the surface of the milk. **Risk of scalding.**

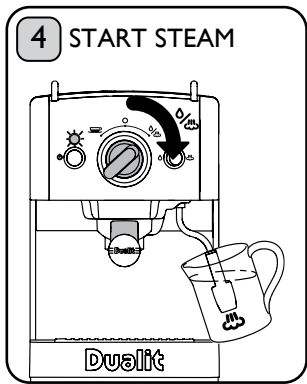

Turn the Control Knob to the steam position. You will hear the Pump operating; this is quite normal. Steam will begin to flow. **Risk of scalding.**



To heat milk using steam, leave the Steam Wand positioned just under the surface of the milk. Do not move the jug. **Risk of scalding.**



To froth milk, introduce air to the milk by slowly lowering the jug ensuring the Nozzle remains under the surface of the milk. **Risk of scalding.**

DISPENSING HOT WATER

CAUTION: WATER WILL BE HOT AND BE DISPENSED AT HIGH PRESSURE. SUBMERGE THE WAND TO REDUCE SPLASHING.

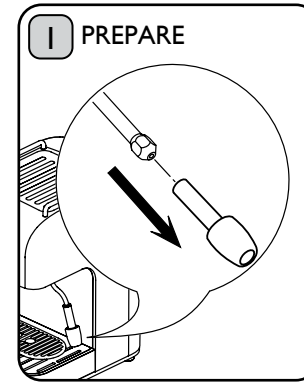

Remove the Froth Nozzle from the Steam Wand. **Caution: Wand may be hot.** Ensure the Water Tank is filled with water.



Set the Steam/Water Selector to the water setting.

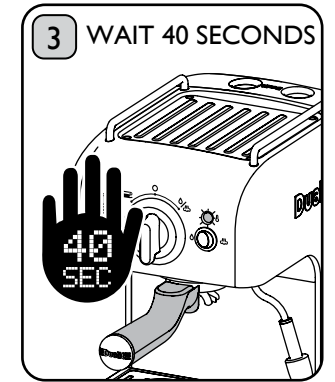

Wait for the Temperature Indicator to go out.

WHEN SWITCHING FROM STEAM TO COFFEE EXTRACTION: WAIT 10 SECONDS BEFORE REMOVING THE HOLDER AFTER DOSING FIRST DRINK IS COMPLETE.

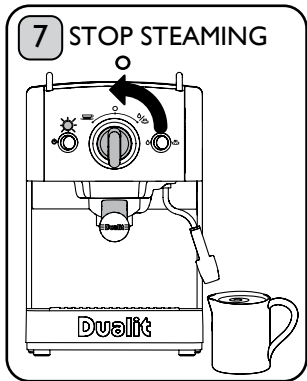

Once you have the desired amount of frothed milk, turn the Control Knob to the 'off' position then move the jug away from the Nozzle.

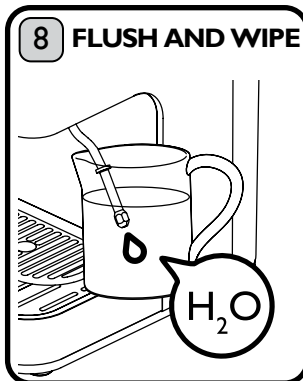

IMPORTANT NOTICE: After each use, flush the Steam Wand by dispensing water or steam to remove any milk residue from inside the Steam Wand. Wipe the Steam Wand.

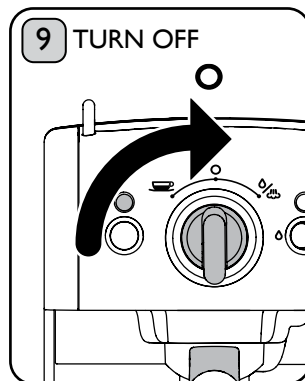

Turn machine off by pressing the Power ON/OFF Switch after you have rinsed through and finished using the machine. This will save energy. **Unplug when not in use.**

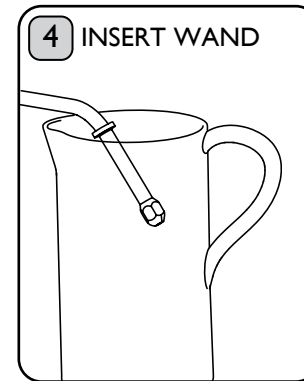

Insert into a deep jug or teapot and point the wand to a side wall to reduce splashback.

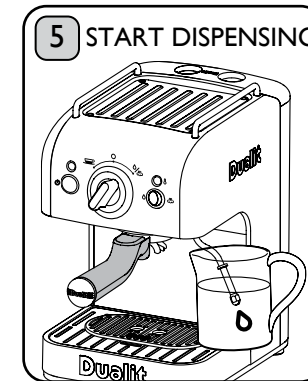

Turn the Control Knob to the steam/water position to start the water flowing. You will hear the Pump; this is quite normal. **Risk of scalding.**

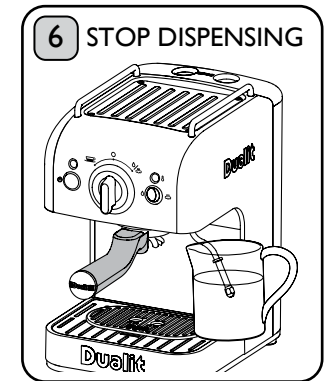

To stop the flow, turn the Control Knob to the 'off' position. The machine will purge to get ready for the next coffee. **Unplug when not in use.**

CLEANING - AFTER EACH USE

BEFORE CLEANING, MAKE SURE THE MACHINE IS SWITCHED OFF, UNPLUGGED AND ALLOWED TO COOL. NOTE: ALWAYS CLEAN YOUR MACHINE BEFORE BEGINNING THE DESCALING PROCESS.

Do not wash any of the plastic accessories in a dishwasher.



Turn the Filter Holder upside down over a bin and knock out the grounds. Be careful not to throw away the Cup Filter.

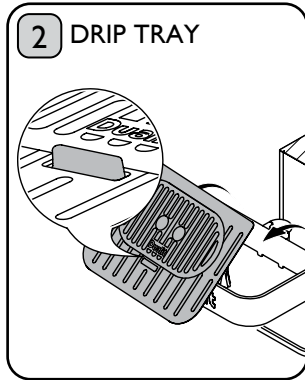

Empty the Drip Tray regularly. If the red 'Tray Full' indicator is visible, empty immediately. Remove the Non-Slip Mat and rinse after each use.

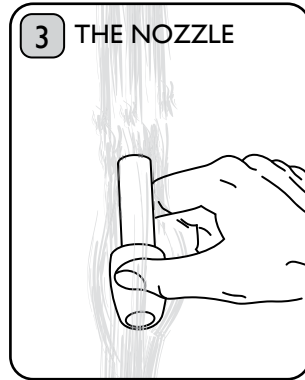

Pull the Froth Nozzle off the Wand and wash under running water to remove any milk residue.

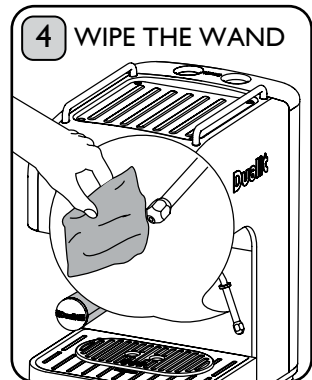

After each use, clean the Wand with a damp cloth. There should be no milk residue visible.

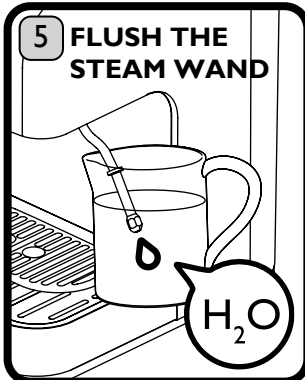

IMPORTANT NOTICE: After each use, flush the Steam Wand by dispensing water (see page 19) or steam, this will remove any milk residue from inside the Steam Wand.

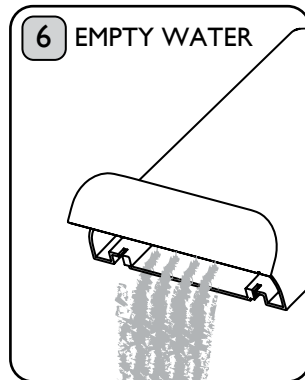

Empty and rinse out after each session and refill with fresh water just before you make your next round of espresso.

CLEANING - MONTHLY

BEFORE CLEANING, ENSURE THE MACHINE IS SWITCHED OFF, UNPLUGGED AND ALLOWED TO COOL. USE DUALIT CAPSULES OR ESE PODS TO REDUCE FREQUENCY OF CLEANING.

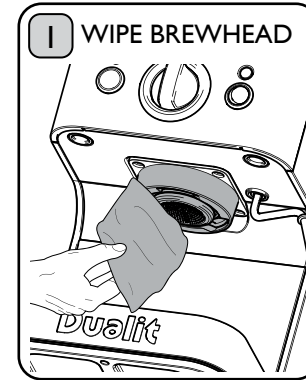

Wipe the entire Brewhead area and ensure it is completely free of coffee grounds. Fine coffee grounds can block the Showerhead.

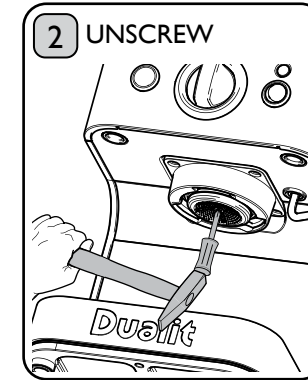

Using a screwdriver and hammer, **GENTLY** tap the screw to dislodge any dried coffee. Then unscrew anti-clockwise.

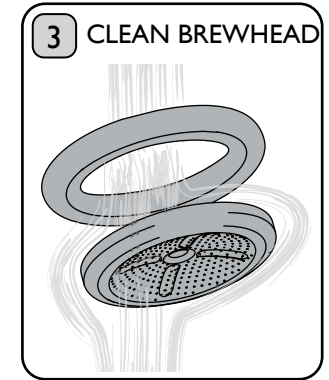

Thoroughly clean the Showerhead and Gasket to remove any coffee grounds. Use the Filter Pin to unblock or rinse in suds.

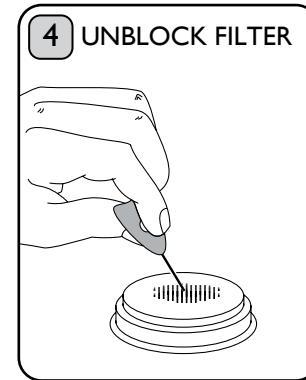

Filters often get blocked with prolonged use. To unblock, use the Filter Pin and push through the central hole on both sides of the Filter to unblock.

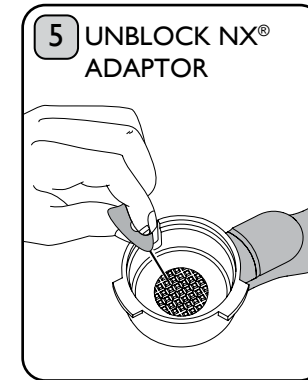

The Filter Plate on the NX[®] Adaptor can get blocked with dried coffee. To unblock the holes, use the Filter Pin to clean between the holes.

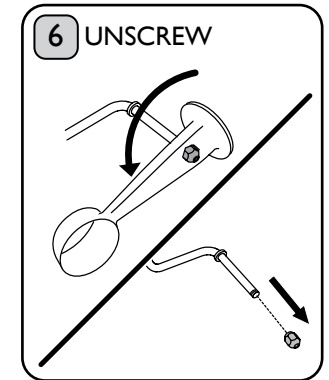

Locate the Measuring Spoon onto the Steam Wand Nut. Unscrew anti-clockwise and remove.

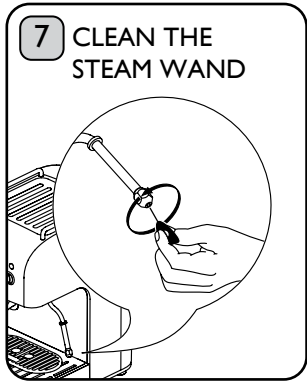

Use the Steam Pin to remove dried milk from inside the Steam Wand. Use the Measuring Spoon to place the Nut back on the Steam Wand. Screw clockwise until tight.

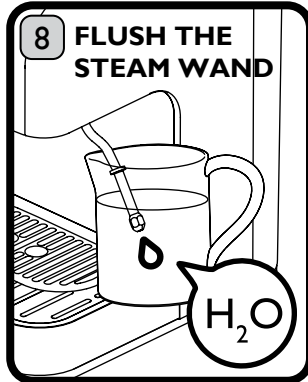

IMPORTANT NOTICE: Turn on your machine. Flush the Steam Wand by dispensing water or steam to remove any milk residue from inside the Steam Wand. Risk of scalding.

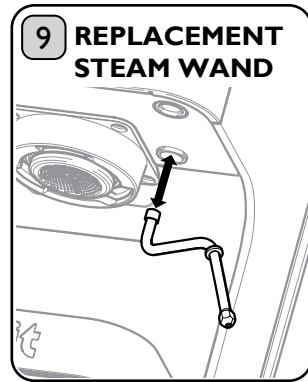

If the Steam Wand is completely blocked, it is possible to remove the Wand assembly for cleaning. Visit our service section on www.dualit.com/support for replacement advice or to purchase spare parts.

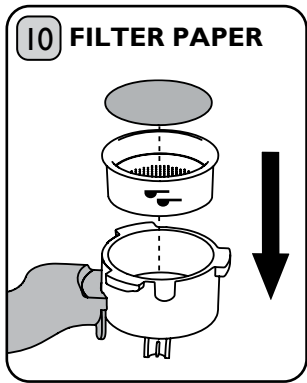

Remember to use Filter Papers. These can help to prevent Filter blockages. These are available directly from www.dualit.com/filterpapers.

MAINTENANCE

Kilrock Espresso & Coffee Machine Descaler

A build-up of limescale can cause your coffee machine to stop working. Dualit recommends descaling at least once a month and more regularly in hard water areas, to prevent limescale build up in your coffee machine. The descale cycle will take approximately 45 minutes to complete. Each box includes two descale treatments.

OSCAR Water Softening Bags

A build-up of limescale is one of the most common causes of coffee machine break downs. OSCAR Water Softening Bags (OSCAR Bags) are placed in your coffee machine's water tank and work to soften the water, reducing limescale build-up. The OSCAR Bags are suitable for all Dualit Pump Espresso Coffee Machines with Water Tanks.

For more information, visit our website www.dualit.com/machine-care.



DESCALE REGULARLY

HARD WATER WILL CAUSE LIMESCALE BUILD-UP, RESULTING IN BLOCKAGES THAT CAUSE PERMANENT DAMAGE. IMPORTANT NOTICE: PRODUCT FAILURE DUE TO THE BUILD UP OF LIMESCALE IS NOT COVERED BY GUARANTEE.

Dualit recommends descaling regularly, in a well-ventilated area to prevent limescale build up in the machine. See limescale warning on page 6-7 for frequency in your area in accordance with the hardness of your water. It is essential that a compatible descaler is used - visit www.dualit.com for descaler options. The descale process takes approximately 30 minutes.

CAUTION: AVOID CONTACT WITH DESCALING SOLUTION. STEAM RELEASED DURING DESCALING PROCESS MAY BE HARMFUL. RISK OF SCALDING AND INJURY.

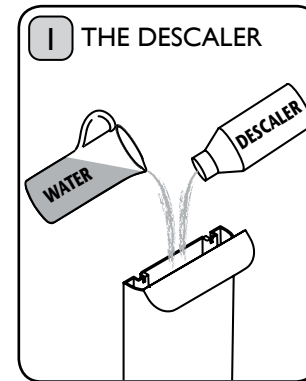

Ensure your descaling product is suitable for coffee machines; **follow descaling product instructions carefully.** If you are using a water softener, ensure water softener is removed before adding descaler. Fill Water Tank with the descaling solution.

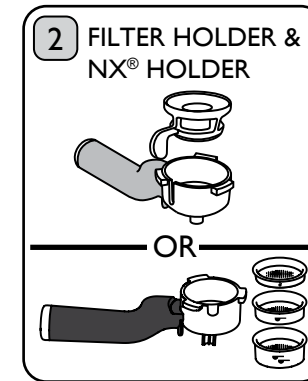

Place the Holder most frequently used into the machine, ensuring it is empty. If both Holders and Filters are used frequently, cycle between them. **Do not soak the holders in descale solution.** Ensure they are rinsed thoroughly after descaling.

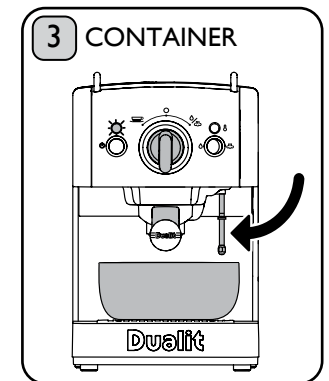

Place a container with a capacity of more than 1 litre on the Drip Tray underneath the Holder. **Caution: Do not remove the Drip Tray.** Remove Froth Nozzle from the Steam Wand. Direct Steam Wand into container.

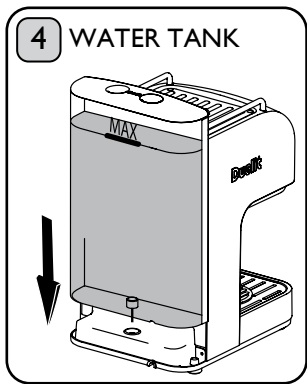

Insert Water Tank. Plug machine in and turn on. Wait until machine has reached operating temperature. **Caution: Keep hands away from Steam Wand at all times. Risk of scalding.**

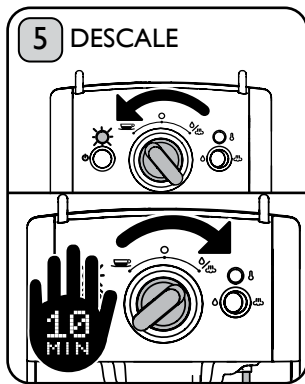

Ensure Steam/Water Selector is set to water. Turn dial completely to the right to dispense half a tank of water through the Steam Wand. **Risk of chemical inhalation.** If no water comes out, allow to stand for 5 minutes and repeat above, allowing the pump to run for up to 1 minute even if no water dispenses. Turn dial fully to the left and allow the remaining descale solution to dispense from the Showerhead, not allowing the tank to run dry. **Risk of chemical inhalation.** Turn dial to 'Off'.

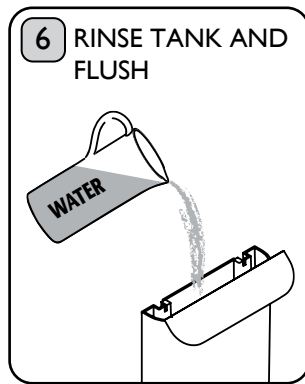

Thoroughly rinse Water Tank and fill with fresh water. Repeat steps 2-5 twice with water only to remove any traces of descaling solution. If you are using a water softener, ensure that it is replaced into the Water Tank once the Water Tank is clean. **Risk of chemical ingestion.**

EcoPress™

ALUMINIUM CAPSULE RECYCLER

EcoPress™ your used aluminium capsules to separate the coffee from the capsule for easy kerbside recycling.

Available to purchase from

WWW.DUALIT.COM/ECOPRESS

Dualit®



JOIN THE CAFÉ CLUB

- Loyalty stamp with every 60 pack you buy
- Two FREE stamps with your first capsule order
- Collect 9 stamps & claim 50 FREE capsules
- Great value & easy ordering

WWW.DUALIT.COM/CAFE-CLUB



RECIPES

An ESPRESSO is 35ml of water run through ground coffee in the machine. Once the espresso is extracted (the basis of most coffee drinks) add water or milk to the coffee to create different types of drinks.

LUNGO is a longer espresso run through the machine; all the water runs through the beans, same flavour less intensity.

RISTRETTO is an espresso made with less than the usual amount of water, filling a small espresso cup half-full of very strong coffee.



AMERICANO

1. Pour hot water into a cup (water volume will depend on coffee strength preference).
 2. Top hot water with freshly extracted espresso.
 3. Add milk or enjoy it black.
- This gives a similar strength (but different flavour) to a filter coffee machine.

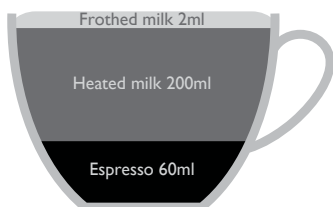

LATTE

1. Make espresso for the latte.
2. Steam the milk by following steps 1-5 (pg 17-18).
3. Pour steamed milk over the espresso, adding a little froth at the end.
4. Tip: Add flavoured syrups to enhance the flavour of the coffee (optional).

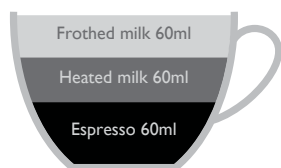

CAPPUCCINO

1. Make espresso for the cappuccino.
2. Steam, froth and texturise the milk by following steps 1-7 (pg 17-18).
3. Pour a third of the hot textured milk then spoon a third of the foamed milk over the espresso.
4. Sprinkle with cinnamon or powdered cocoa to finish (optional).

FOR MORE RECIPES PLEASE VISIT WWW.DUALIT.COM/RECIPES

TROUBLESHOOTING



IMPORTANT: FAILURE TO DESCALE AND CLEAN YOUR MACHINE WILL INVALIDATE YOUR GUARANTEE.

***TO CONTACT CUSTOMER SERVICES, PLEASE EMAIL INFO@DUALIT.COM WITH YOUR MODEL AND SERIAL NUMBERS.**

TEST	RESULT	SOLUTION(S)
NO COFFEE FLOWING FROM BREWHEAD		
THE TAMP TEST Dispense water through the Brewhead with the Cup Filter in place. Ensure NO coffee is in the Filter. If you see no water after 7 seconds STOP the test.	No water	1. Water Tank is not correctly seated in position. Locate Water Tank (see page 10, fig 2).
	Water flow improves	1. The Showerhead and Cup Filter may be blocked. Clean Showerhead and Cup Filter (see page 21-22). You may also need to descale the machine (see page 23). 2. You may be tamping too hard. LIGHTLY 'tamp' the coffee grounds (see page 15, fig 5). 3. The Cup Filter is blocked because the coffee grind is too fine. Ensure you are using setting 3-5 on the Dualit Coffee Grinder or use a pre-ground coffee suitable for espresso machines. Clean the Cup Filter (see page 21, fig 4). 4. There is too much coffee in the Cup Filter. Use the Measuring Spoon (see page 15, fig 4).

POSSIBLE CAUSE(S)	SOLUTION(S)
NO STEAM FLOWING FROM STEAM WAND	
1. Water Tank is not correctly seated in position.	1. Locate Water Tank (see page 10, fig 2).
2. Steam Wand is blocked.	2.1. Clean Steam Wand (see page 21-22, fig 6-9). 2.2. Descale (see page 23). 2.3. If you are unable to unblock your Steam Wand then contact Dualit customer services* for help.
COFFEE LEAKING FROM THE BREWHEAD	
1. Dried coffee on the Gasket.	1. Clean Gasket (see page 21, fig 3).
2. ESE pod or Capsules not seated correctly.	2. Check the Capsule is in place. If using ESE pod, tuck the tab under (see page 14, fig 4-5).
3. Blocked Brewhead.	3. Clean Showerhead (see page 21, fig 3).
4. Damaged Brewhead Gasket.	4. To obtain a new Gasket contact Dualit customer services* for help.

POSSIBLE CAUSE(S)	SOLUTION(S)
WATER DRIPPING FROM THE BREWHEAD WHEN STEAMING	
1. Excess water in the Brewhead is left over from previous operation.	1. This is not cause for concern. This will automatically stop when the machine has finished steaming.
MY MACHINE IS MAKING A LOUD AND CONTINUOUS PUMPING NOISE	
1. Water Tank is not correctly seated in position.	1. Locate Water Tank (see page 10, fig 2).
2. Water Tank is empty.	2. Fill Water Tank (see page 10, fig 2).
MY MACHINE HAS STOPPED DURING USE	
1. Water Tank is empty.	1. To prevent an air lock firstly remove the Filter Holder. Fill Water Tank (see page 10, fig 2). Your machine is now ready to extract your next coffee.
MY MACHINE IS NOT DISPENSING CORRECT AMOUNT OF COFFEE OR TEA	
1. The flow of the coffee is too long/short.	1. For your desired amount of coffee, let the machine run for longer if flow is too short/stop machine earlier if flow is too long.
STEAM IS VENTING FROM THE DRIP TRAY	
1. Water is being purged through the machine to reduce operating temperature ready for the next coffee.	1. This is not cause for concern. This will automatically stop when the machine has finished purging.
MY COFFEE OR TEA IS NOT HOT ENOUGH	
1. Filter Holder is not pre-heated.	1. Prime machine. (see page 10).
2. Cup or mug is not pre-warmed.	2. Warm cup (see page 10). You can also place your cups to warm on the Cup Warming Plate.
AFTER FROTHING MILK, MY MILK IS NOT FOAMY	
1. Milk is not cold or fresh enough.	1. It is easier to make froth using cold semi-skimmed milk in a stainless steel jug.
2. Steam Wand is blocked with milk residue.	2.1. Clean Steam Wand (see page 21-22, fig 6-9). 2.2. Descale (see page 23).
MY COFFEE HAS NO CREMA	
1. The Cup Filter is blocked because the coffee grind is too fine/too coarse.	1. Ensure you are using setting 3-5 on the Dualit Burr Coffee Grinder, 4-6 on the Dualit Handheld Grinder or use a pre-ground coffee suitable for espresso machines.
2. Ground coffee is not fresh.	2. Ground coffee only has a three-day shelf-life, so grind only what you need.
3. Thermobloc is too hot after steaming.	3. Flush out excess heat by dispensing water.
MY COFFEE IS WEAK	
1. The volume of coffee dispensed is too high.	1. Ensure you are using the correct type and strength of coffee for the type of drink you are making. See page 26 for recipes.

2. Coffee grind is too coarse.	2. Ensure you are using setting 3-5 on the Dualit Burr Coffee Grinder, 4-6 on the Dualit Handheld Grinder or use a pre-ground coffee suitable for espresso machines.
3. Tamping too light.	3. If you are struggling to control your coffee flow rate, try tamping a little harder. The harder you tamp the longer the coffee will take to extract, thus increasing the strength and improving the flavour of the coffee.
4. Using the incorrect pre-ground coffee.	4. Avoid pre-ground coffee that states that it is suitable for cafetieres.
5. Incorrect dose of coffee is being used.	5. Add more coffee to the Portafilter. (See page 15).
6. You like your coffee extra strong.	6. Use the double espresso dose to make a single coffee.
7. When using NX [®] Adaptor: Dried coffee on the Filter Plate.	7. Use the Filter Pin to remove the dried coffee.
8. When using NX [®] Adaptor: The NX [®] Adaptor is not fully locked in position.	8. Locate and fully lock the Holder. (see page 16, fig 1).
9. When using NX [®] Adaptor: Damaged seal.	9. For spare parts please visit www.dualit.com/support or contact Dualit customer services* for help.
MY CAPSULE DEFORMS AND NO COFFEE FLOWS	
1. Capsule requires piercing.	1. See Capsule types table (page 11, fig 1) to see if you require the Capsule Piercing Tool.

TEST	RESULT	SOLUTION(S)
NO COFFEE OR TEA FLOWING WHEN USING THE NX[®] ADAPTOR		
THE NX[®] ADAPTOR TEST Dispense water through the NX [®] Adaptor. Ensure NO Capsule is inside.	No water	1. Water Tank is not correctly seated in position. Locate Water Tank (see page 10, fig 2).
	Water in drip tray	1. The Showerhead and NX [®] Adaptor may be blocked. Remove the Showerhead and clean. Use the Filter Pin to clean out the holes in the NX [®] Adaptor. Descale your machine with the NX [®] Adaptor locked tightly in place. (see page 23-24).
	Water flow improves	1. The coffee/tea in the Capsule is stale. Check Capsule best before date on the Capsule packaging.
		2. Capsule needs piercing, see page 11. 3. We recommend only the use of Dualit Capsules.
Water leaking from NX[®] Adaptor	1. Check the NX [®] Adaptor Seal is there and has not split, see page 9. If missing or split, for spare parts please visit www.dualit.com/support or contact Dualit customer services* for help.	

GUARANTEE

This appliance is of excellent quality and construction. However, if any defects in materials or workmanship do appear during the relevant guarantee period, we will, at our discretion, either repair or replace the defective parts, free of charge, subject to the terms and conditions of our Guarantee shown below.

This Guarantee covers both parts and labour. Carriage is not included.

Your Guarantee period is as follows:

- 1 year

This Guarantee provides benefits which are additional to, and do not affect, your statutory rights. This Guarantee does not cover the cost of returning the product to the dealer from whom it was purchased or to ourselves. This Guarantee applies only to products sold and located in mainland Great Britain. It does not cover liability in respect of or replacement of plugs, cables or fuses and also does not cover defects due to:

- Failure to use or maintain product in accordance with Dualit's instructions.
- The product being connected to an unsuitable electricity supply.
- Accidental damage to or abuse or misuse of the product.
- Product modification, except by Dualit or approved agent.
- Dismantling of or interference with the product.
- Theft or attempted theft of the product.

Before returning any product under this Guarantee, please check that:

- You have followed the product instructions correctly.
- Your mains electricity supply is functional.
- The defect is not due to a blown fuse.

If you wish to claim under this guarantee you should:

- Send the product, postage or carriage paid, to the dealer from whom it was purchased or to Dualit direct.
- Ensure that the product is clean and packed carefully (preferably in its original carton).
- Enclose details of your name, address and telephone number and when and where the product was purchased, together with proof of purchase (e.g. a till receipt).
- Give exact details of the nature of the defect.

This Guarantee does not cover any other claims whatsoever, including, without limitation, any liability for incidental, indirect or consequential damage, nor does it cover any claims for conversion or modification or for the costs of repair carried out by any third party without the prior consent of Dualit. If replacement parts are fitted to the product this will not extend the period of the Guarantee.

For further advice contact the Dualit customer helpline on +44 (0)1293 652 500 (09:00 to 17:00 Monday to Friday).

Alternatively, email Dualit at info@dualit.com or visit www.dualit.com

Do not throw away the appliance with the normal household waste at the end of its life, but hand it in to an official collection point for recycling. By doing this you help preserve the environment.

BEFORE FIRST USE, DON'T FORGET TO REGISTER YOUR PRODUCT!

Take just 60 seconds to register your product with us and take advantage of these benefits from Dualit:

1. Fast and efficient customer service, important safety advice, access to manuals and product information should you require assistance with your purchase
2. A library of mouth-watering recipes plus regular articles and blogs
3. Be the first to hear about exciting new Dualit products and competitions

Dualit recommends safety first: please register your product so that we can contact you in the unlikely event that a safety notification is issued. Remember to keep your receipt as proof of purchase.

WWW.DUALIT.COM/REGISTER

Register 
my appliance

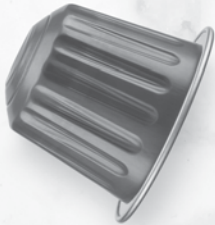

EcoPress™

ALUMINIUM CAPSULE RECYCLER

EcoPress™ your used aluminium capsules
to separate the coffee from the capsule
for easy kerbside recycling.

Available to purchase from

WWW.DUALIT.COM/ECOPRESS



Dualit Limited County Oak Way Crawley West Sussex RH11 7ST

+44(0)1293 652 500 info@dualit.com www.dualit.com